

15 YEARS WARRANTY



ARCHITECTURE COLLECTION 2026-27



The Virgo Group of companies constantly looks out for innovation and challenges in industry where it meets with its passion to excel in whatever it does. Across all its group companies, manufacturing laminates, plywood, aluminum and ACP it maintains a philosophy of reaching out to perfection, no matter what it takes, whether high-end resources or a superlative manpower.



**Delhi Head Office**  
406, 4th Floor, Rectangle No. 1, Behind Select City Mall, District Centre Saket, New Delhi-110017  
PH: +91-98327 22222

**Chandigarh**  
Plot No.-828, Industrial Area, Phase-2, Chandigarh-160002  
PH: +91-172-4011111, 2639222, 2639333  
Fax: +91-172-2639444

**Ahemdabad (Plant)**  
Kheda By Pass, At- Sokhda, Tal- Matar, Dist-Kheda, Gujarat-387570  
E: acp@virgogroup.in

**Delhi**  
Khasra No. 63/9/2 Opp Metro Pillar No. 592 Mundka New Delhi-110041  
Mob.: +91 84102 62222  
E: gmail-delhi@virgoasia.com

**Panchkula**  
Panchkula Plot No. 49, Phase -1 Panchkula-134109  
Mob: +91 70424 59222  
E: pkl.acp@virgoasia.com

**Lucknow**  
2,8/1 Mill Road Aishbagh Near SBI Bank Lucknow-226004  
Mob: +91 97945 98260  
E: lucknow.acp@virgoasia.com

**Jaipur**  
B-23 Sharma Colony Vistar 22 Godam Industrial Area, Jaipur-302019  
Mob: +91 87594 62222  
E: jaipur@virgoasia.com

**Ranchi**  
41, Kokar Industrial Area, Kokar, P.S-Sadar, Jharkhand, Ranchi-834001  
Mob: +91 89092 32222  
E: ranchi.acp@virgoasia.com

**Kolkata**  
Godown No:-10, 284, Maharaja Nanda Kumar Road, (North) Alambazar, Baranagar Jute Mill Compound, Kolkata-700035  
Mob: +91 81780 22755  
E: kolkata.acp@virgoasia.com

**Indore**  
75/2/40 Lasudiya Mori Dewas Naka Indore-452010  
Mob: +91 80127 62222  
E: indore.acp@virgoasia.com

**Mumbai**  
Godawan 12/b, Bldg No.h-5, Shree Arihant Compound Kalher, Bhiwandi Thane-421302  
Mob: +91 72890 94222  
E: mumbai.acp@virgoasia.com

**Bengaluru**  
Municipal No-2/1A, 3Rd Cross, Mysore Road Bangalore-560026, Karnataka  
Mob: +91 70195 77204  
E: bangalore@virgoasia.com

**Hyderabad**  
Dairy Farm Road, Tirumalgiri, Satya Sai Enclave, Road No- 9, H.NO-1-31-15/A, Secunderabad Pin -500015, Telangana.  
Mob: +91 96765 67222  
+91 86440 82222  
E: hyd@Virgoasia.com

**Chennai**  
S.NO.43/2B, Door.no.39 & 40, MGR Road, Vadakarai,Puzhal, Chennai- 600052 Tamil Nadu  
Mob: +91 91768 18123  
E: brchennai.acp@virgoasia.com

**Kochi**  
Address: 19/6-a, Puthiya Road, Kangarappady Choornikkara, Ernakulam, State: Kerala-682021  
Mob: +91 98083 42222  
E: acpkerala@virgoasia.com

**Patna**  
Krisna Niketan, Zero Mile, Patna, Bihar-800026  
Mob.: +91 97715 77565

**Guwahati**  
Katabari, East India Technosys Pvt Ltd, A K Dev Road, Garchuk, Guwahati, Metropolitan - 781035  
Mob: +91 97069 53462  
E: hyd@Virgoasia.com

www.virgolam.com | For More Help: 98327 22222



# LOUVERS

## SURFACE SYMPHONY

15 YEARS WARRANTY



ARCHITECTURE COLLECTION 2026-27

# DISCOVER REFINED STYLE

ELEGANTLY  
MODERN AND  
ECO-CONSCIOUS  
FOR YOUR  
ARCHITECTURAL  
CREATIONS.





# SHAPING ICONIC SPACES

Reimagine your architectural spaces where modern elegance meets intelligent functionality. Transform every façade into a masterpiece that speaks of strength, sophistication, and sustainability. Presenting Virgo ACP Louvers, a perfect blend of design innovation and enduring performance, crafted to redefine the aesthetics of contemporary architecture.

With effortless installation and minimal maintenance, experience the harmony of style and sustainability, where every louver tells a story of excellence, precision, and timeless beauty.





SYMBOLIZING  
VENTILATION  
AND LIGHTNESS

SEAMLESS DESIGN



WHAT MAKES  
VIRGO ACP  
LOUVERS  
A RIGHT CHOICE



**Hassle-Free Installation**  
Enhance your interiors and exteriors effortlessly with a seamless, modern finish.



**Sustainable & Long-Lasting**  
Choose a solution that balances design excellence with eco-conscious durability.



**Versatile in Application**  
Perfect for façades, partitions, shading, and decorative purposes. Designed to adapt to every need.



**Low Maintenance, High Impact**  
Enjoy the beauty of your spaces without worrying about constant care or upkeep.



**Architectural Elegance Redefined**  
Turn every surface into a statement of sophistication, crafted for timeless visual appeal.

TRANSFORM YOUR  
SPACES INTO MODERN  
ELEGANCE & DESIGN



SURFACE  
SYMPHONY



GATE PANELING,  
CANOPY,  
ROOF CLADDING,  
FENCE AND  
MUCH MORE

REDEFINE  
TIMELESS  
ELEGANCE



ACP LOUVER SHADE CODE	ACP LOUVER PANEL SIZE (W x L x H)	DIMENSIONS	NO. OF FLUTES
BAFFLELINE 3876	50MM x 2440MM x 76MM 50MM x 3050MM x 76MM 50MM x 3660MM x 76MM	50mm x 76mm	Baffle Type Flute



**Z PROFILE FOR ACP BAFFLE 3876 ASSEMBLY**

Z profile material made of 2mm thick paint coated MS

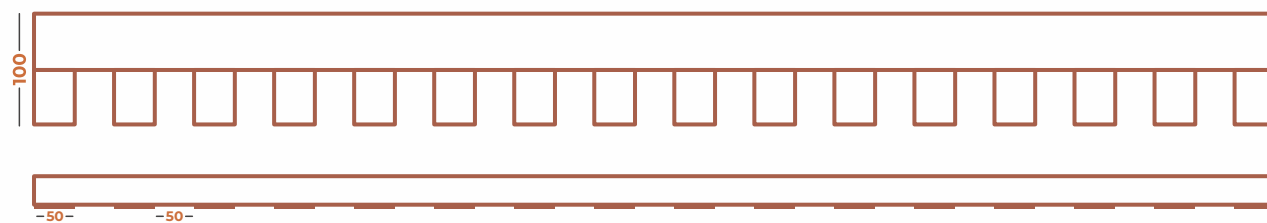
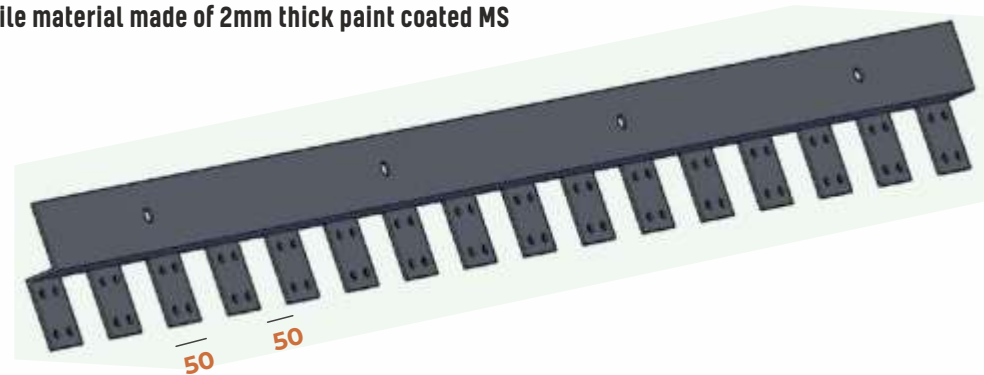

ACP LOUVER SHADE CODE	ACP LOUVER PANEL SIZE (W x L x H)	DIMENSIONS	NO. OF FLUTES
BAFFLELINE 50100	50MM x 2440MM x 126MM 50MM x 3050MM x 126MM 50MM x 3660MM x 126MM	50mm x 126mm	Baffle Type Flute



**Z PROFILE FOR ACP BAFFLE 50100 ASSEMBLY**

Z profile material made of 2mm thick paint coated MS

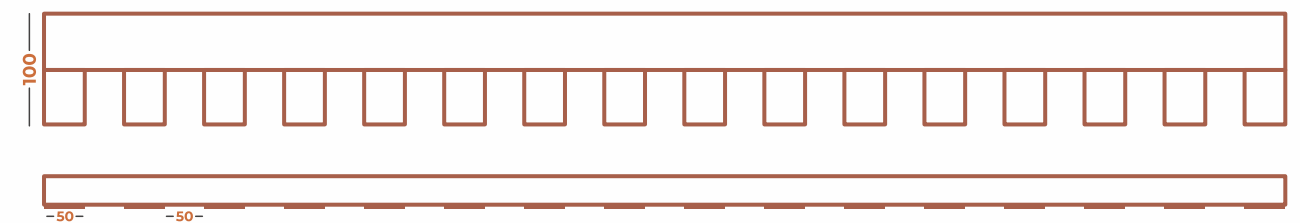
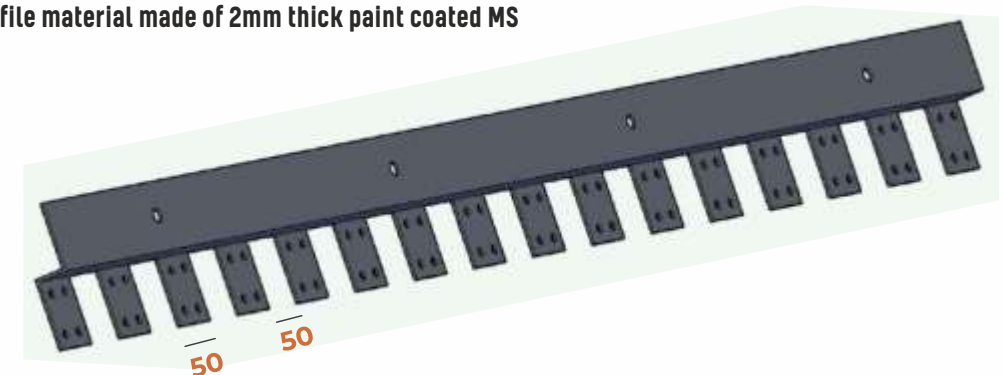



3200 Series



5500 Series



VL 911 | CHINTO PINE



3200 Series



5500 Series



VL 912 | BURMA TEAK



3200 Series

5500 Series



VL 922 | AMERICAN WALNUT



3200 Series

5500 Series



VL 984 | CLASSIC WALNUT

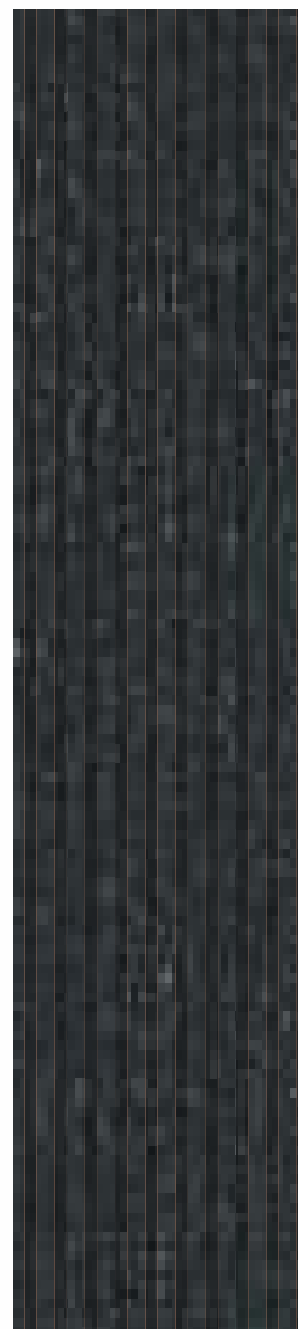

3200 Series

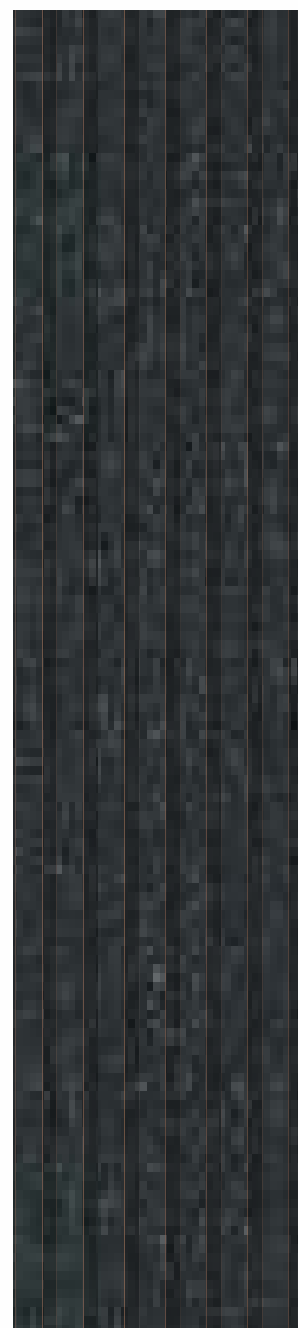

5500 Series



VL 611 | IRON GREY

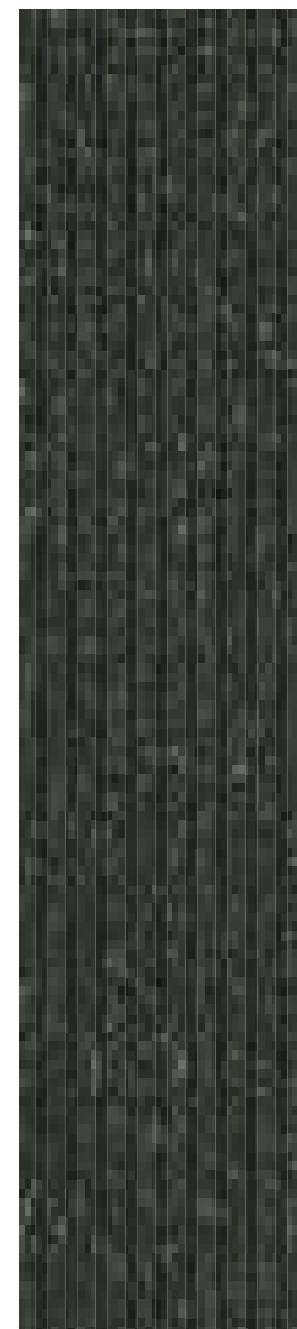

3200 Series

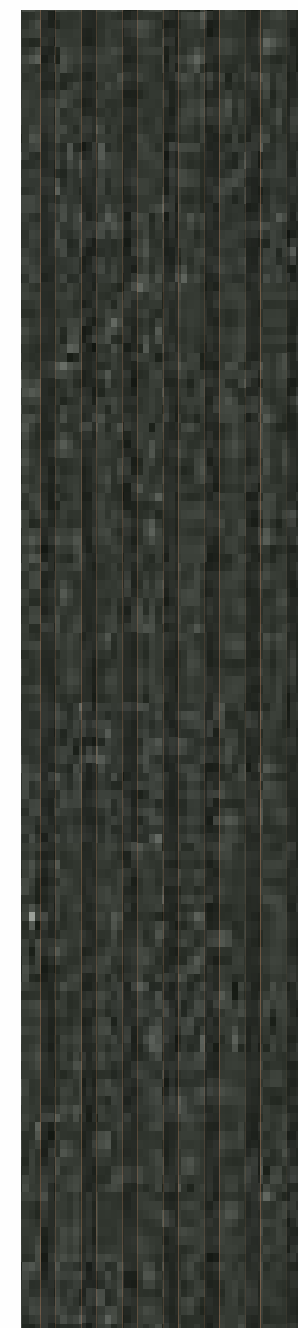

5500 Series



VL 633 | QUARTZ GREY

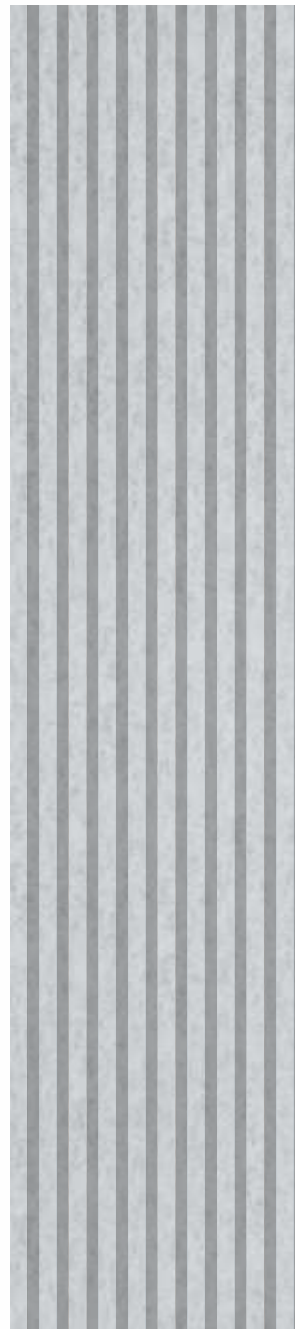

3200 Series

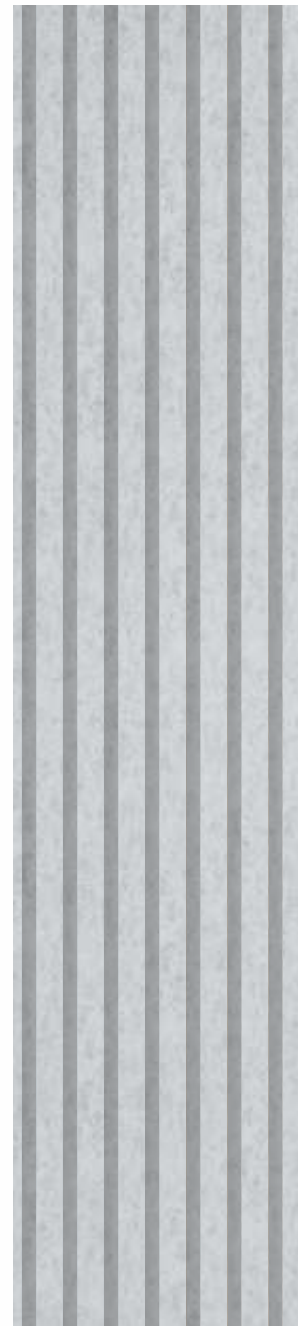

5500 Series

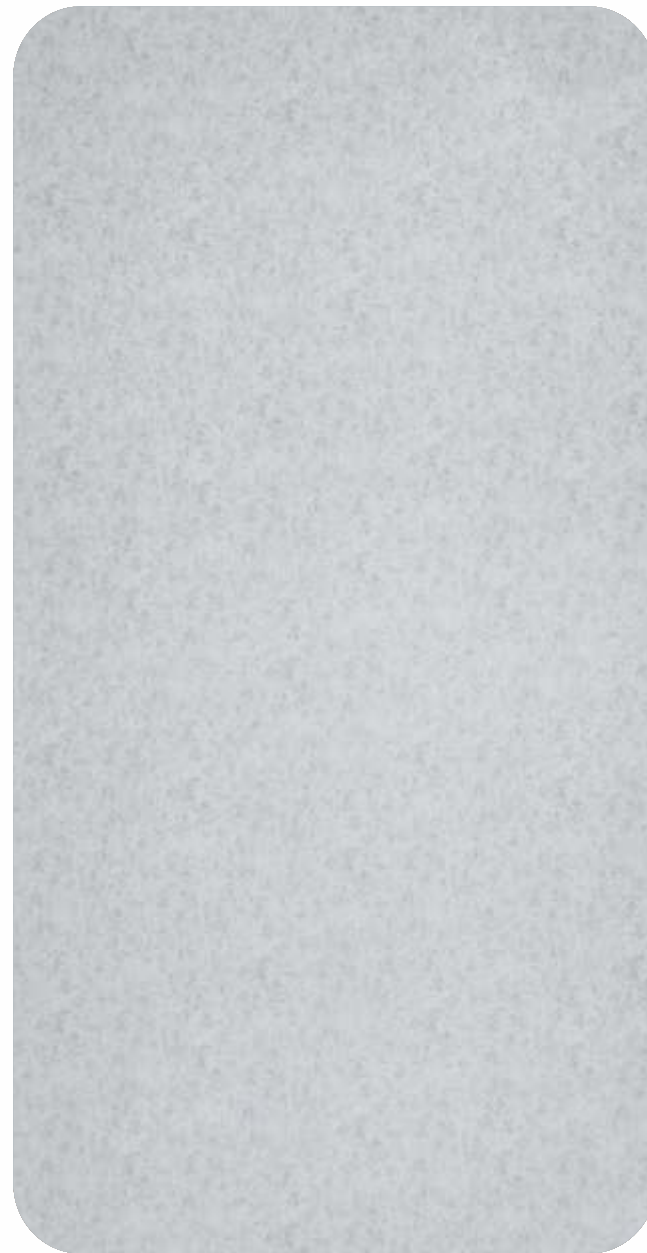

VL 7001 | INDUSTRIAL ASH



3200 Series



5500 Series



VL 7004 | OCEAN HAZE

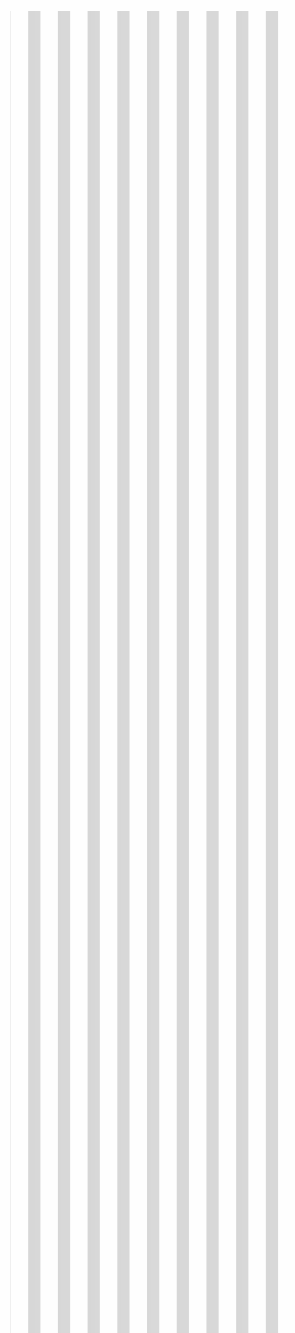

3200 Series

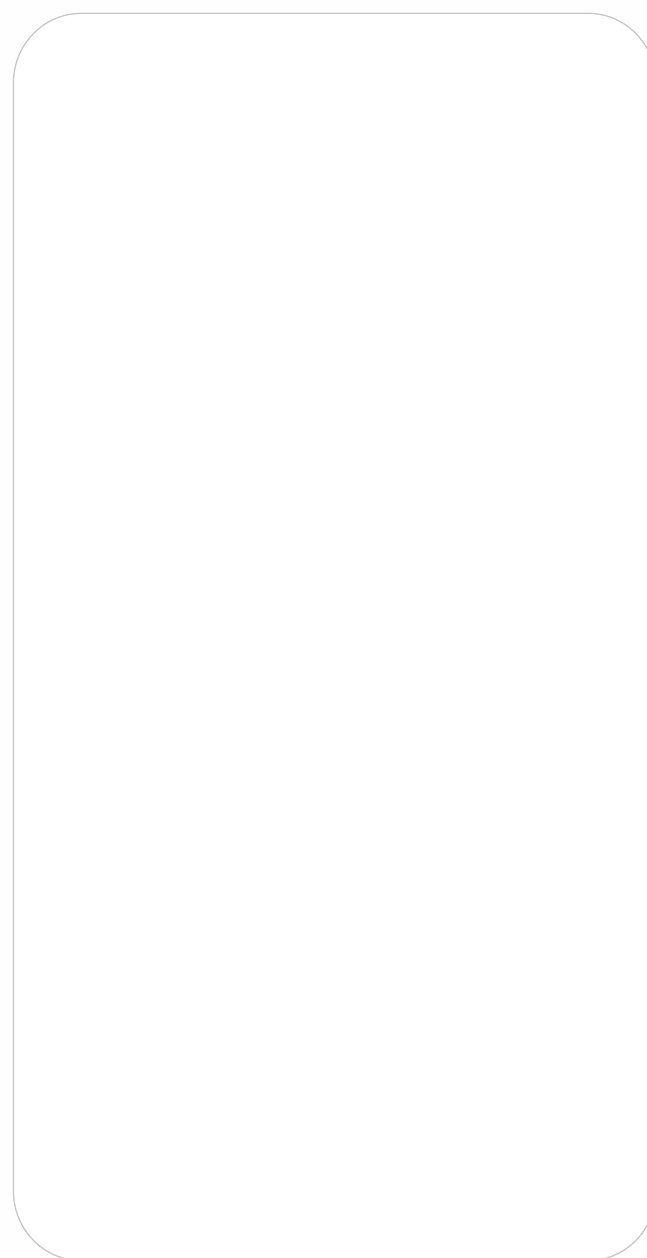
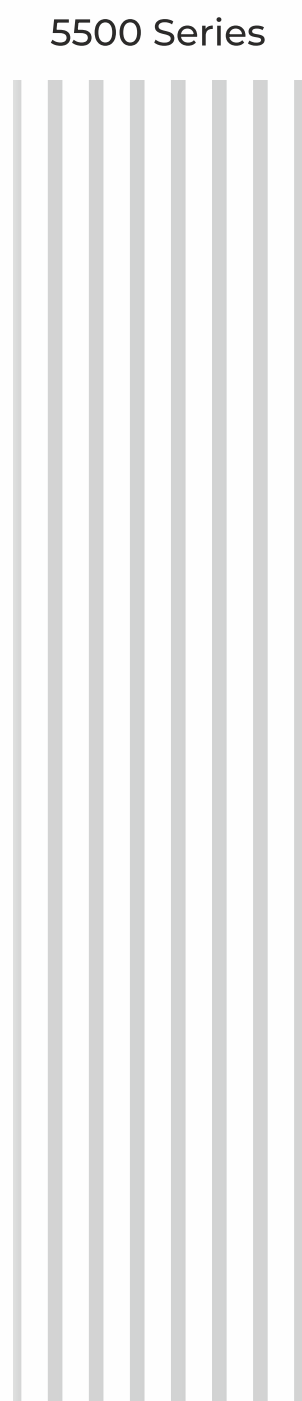

VL 331 | ICE WHITE



3200 Series

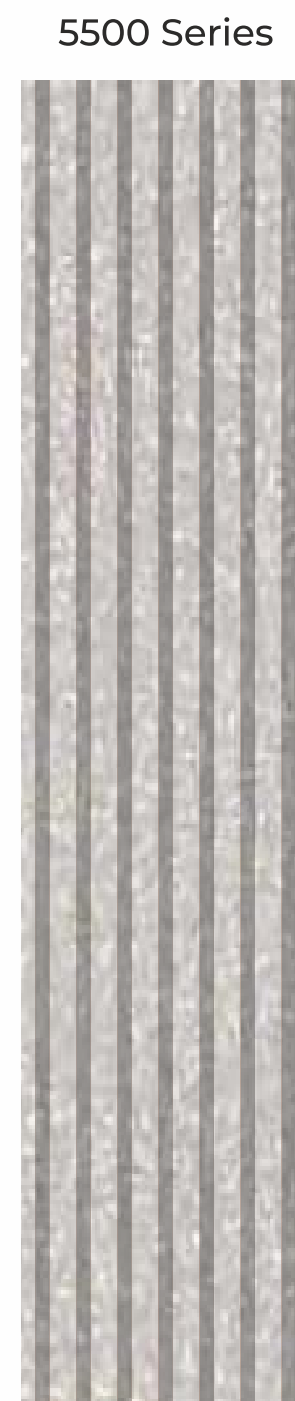

VL 701 | EXOTIC SILVER

15 YEARS WARRANTY

# TECHNICAL SPECIFICATION

Product Type: Corrugated Louvers

Series	Panel Size (W x L x H)	Profile Dimensions	No. of Boxes	No. of Slots
3200	616mm x 2440mm x 30mm	25mm x 30mm x 32mm x 30mm x 25mm	11	10
5500	765mm x 2440mm x 30mm	30mm x 30mm x 55mm x 30mm x 30mm	9	8

## Dimensional Tolerances

Parameter	Tolerance
Panel Thickness	±5mm
Panel Length	±4mm
Panel Width	±10mm
Panel Squareness	±5mm
Box Dimensions	±2mm
Slot Dimensions	±2mm
Panel Weight	±5%

## Packaging Details

3 Sets per pack

Dimensions:	3200 Series: 2440mm (L) x 616mm (W)
	5500 Series: 2440mm (L) x 765mm (W)



DISCOVER OUR LEGACY OF INNOVATIVE DESIGNS AND FUTURISTIC SOLUTION



### TEST CERTIFICATES

To view the test certifications please scan the QR Code



### CORPORATE PROFILE

To download the Corporate profile please scan the QR Code



### CORPORATE APPROVAL

To view the Corporate approvals please scan the QR Code



### CORPORATE VIDEO

To watch the corporate video please scan the QR Code



### VIRGO CLADDING

To download Cladding Catalogue please scan the QR Code



### VIRGO ACP PROJECTS

To view the projects done please scan the QR Code



### VIRGO ACP

To download the ACP Catalogue please scan the QR Code

